

CONTEMPORARY MIXTURES SURFACES II

Living ceramics

CREATIVE CERAMICS



CONTEMPORARY MIXTURES SURFACES II

Bera&Beren

Lusitan & Catalan Limestone Ceramics
Caliza Lusitana & Catalana Cerámica

PAG. 10 - 17

Floss

Natural Cement Ceramics
Cemento Natural Cerámico

PAG. 18 - 23

Ground

Mixed Surfaces Ceramics
Mezcla de Texturas Cerámica

PAG. 24 - 31

Gubi

Micro Cement Ceramics
Micro Cemento Cerámico

PAG. 32 - 37

Lightwood

Natural Brushed Oak Ceramics
Roble Natural Cepillado Cerámico

PAG. 38 - 45

Tesla

Natural Saw Marked Oak Ceramics
Roble Aserrado Natural Cerámico

PAG. 52 - 59

Zero

Laminated Steel Ceramics
Acero Laminado Cerámico

PAG. 60 - 63

Mayolica

Natural Mayolica Ceramics
Mayólica Natural Cerámica

PAG. 64 - 71

White&Glass

Special Whites & Glass Ceramics
Blancos Especiales & Vidrios Cerámicos

PAG. 72 - 77

At Living we are guided by the desire of creating versatile ceramic solutions for interior design and architecture. Claddings - on floors, walls, countertops, steps... - are the skin of our homes, and we believe that it is necessary to take care and pay attention to them. We feel a true passion for good design, which is why we manufacture all our products in Italy and Spain, referential countries in ceramic design. We are committed to a material such as ceramics that makes it easier to obtain original and practical resources. Our ultimate objective is customer satisfaction, and we focus the professionalism and thoroughness of our work on this point. We strive in creating products that respond to today's requirements, that are adapted to the users needs, and are in line with the new trends. We are committed to avant-garde design. We work with two types of products: mass colored porcelain lines, ideal both for outdoors and indoors in formats from 5x5 mosaics to 60x180 cm pieces; and white glazed paste in measurements from 7.5x15 cm to a maximum of 40x120 cm. By combining creativity with the infinite possibilities of ceramics we have created Living, a brand that is capable of facing current challenges.

En Living nos guiamos por el deseo de crear soluciones cerámicas versátiles para el interiorismo y la arquitectura. Los recubrimientos de suelos, paredes, encimeras, peldaños... son la piel de nuestros hogares y espacios públicos; y creemos que es necesario cuidarlos y prestarles atención. Sentimos verdadera pasión por el buen diseño por eso fabricamos todos nuestros productos en España e Italia, países referentes en el diseño cerámico. Apostamos por un material que facilita la obtención de recursos originales y prácticos, como es la cerámica. Nuestro fin último es la satisfacción del cliente y en ello ponemos nuestra profesionalidad y la rigurosidad de nuestro trabajo. Nos esforzamos en crear productos que respondan a las exigencias actuales, adaptados a las necesidades de los usuarios y en consonancia con las nuevas tendencias. Encontramos dos tipos de producto: porcelánico de masa coloreada, idóneo para exteriores e interiores en formatos que van desde mosaicos de 5x5 hasta piezas de 60x180 cm; y pasta blanca esmaltada en medidas desde los 7,5x15 hasta máximos de 40x120 cm. Estamos comprometidos con el diseño de vanguardia. Conjugando la creatividad con las posibilidades infinitas de la cerámica, hemos creado Living, una marca capaz de afrontar los retos actuales.







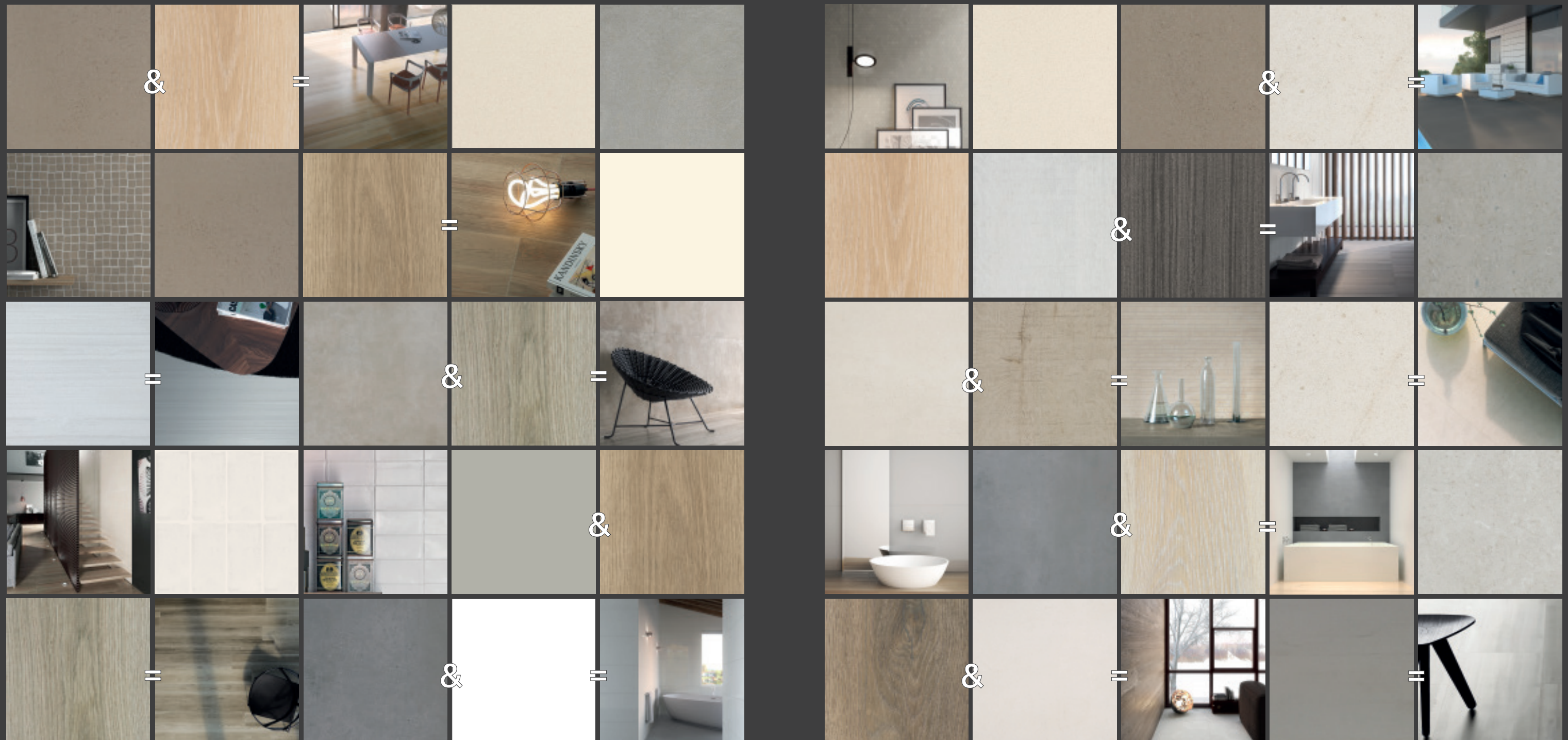





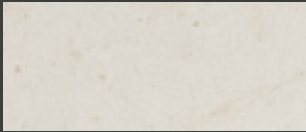
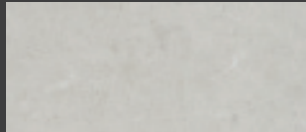
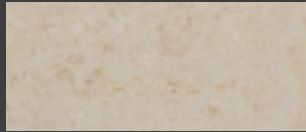
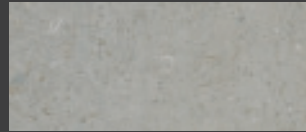

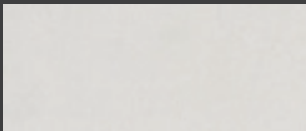
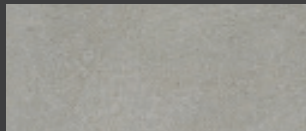
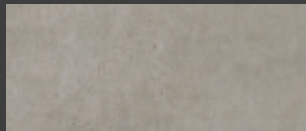
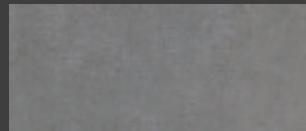
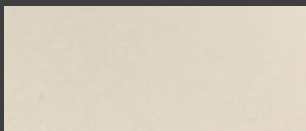
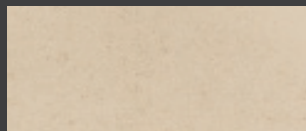
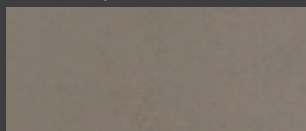
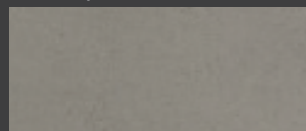
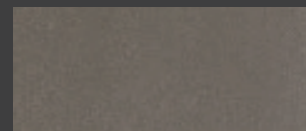
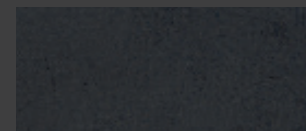
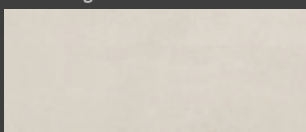
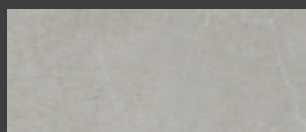
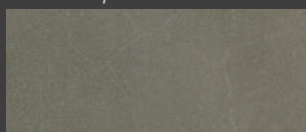
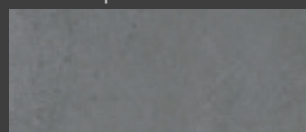



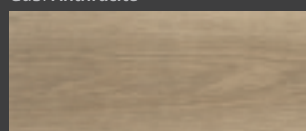
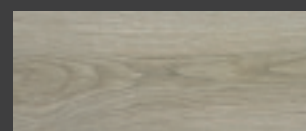

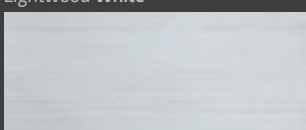
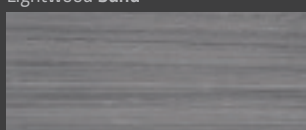

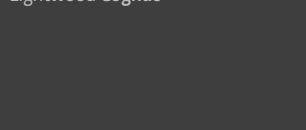
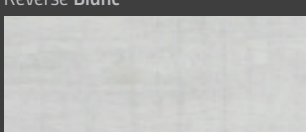
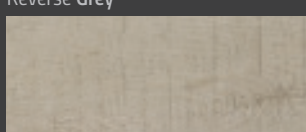
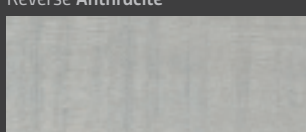

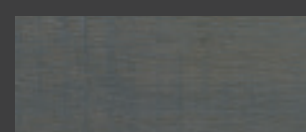
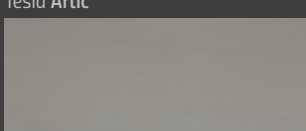
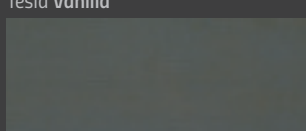
The eight collections we are launching from Living suggest a rich blend of materials and finishes. They are designed as a whole, so that they are easy to combine with each other, regardless of the line and the chromatic choice. They are lines that follow the current trend of joining different surfaces. Experimenting with this blend of textures is the leitmotif which gives rise to a material conception of the pieces. They are sophisticated finishes achieved through a game with the material and an evolved design. The result: materials that bring poetry to everyday life. All these products have the same thickness, allowing almost infinite combinations. All the lines can be found in a wide variety of formats, responding to the demands of today's architecture. We have used current technologies such as ceramic color digital printing, and technology forefront methods such as directly printing on the glazing and "masking", which have enabled us to create light and beautiful designs with great personality and with unprecedented finishes and textures.

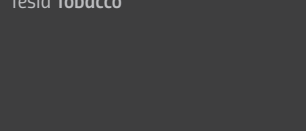
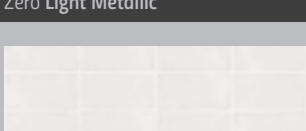
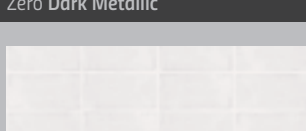
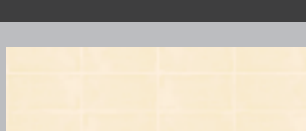
Las ocho colecciones que lanzamos desde Living proponen una rica mezcla de materiales y acabados. Están concebidas como un todo, de forma que resulta sencillo combinar unas con otras, independientemente de la colección y la elección cromática. Son colecciones que siguen la línea actual de unión de diferentes superficies. La experimentación con esa mistura de texturas es el leit motif que da pie a una concepción matérica de las piezas. Sofisticados acabados conseguidos a través de un juego con la materia y un diseño evolucionado. El resultado: materiales que aportan poesía a la vida cotidiana. Todos ellos con el mismo espesor, lo que permite combinaciones cuasi infinitas. Todas las colecciones se encuentran en una amplia variedad de formatos, respondiendo a las exigencias de arquitectura del momento. Hemos utilizado tecnologías actuales como impresión digital en colores cerámicos, y métodos a la vanguardia de la técnica, como la impresión directa en esmaltes y el masking, que nos han permitido crear diseños ligeros y bellos, de gran personalidad y con acabados y texturas inéditas.

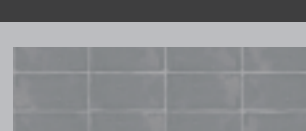
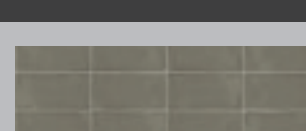
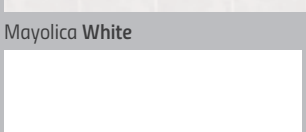

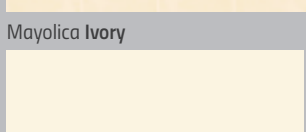
In the design of the lines we have taken into account the latest trends in color, but at the same time we have created a timeless tonal range, which does not go out of fashion. These are color plans that are focused on simplicity and beauty, with sobriety and elegance as qualities that dominate the proposals. It is a range of natural colors capable of creating surfaces with unique personality. The group of lines has great material versatility, as it is inspired in and reproduces materials such as wood, cement, natural stone, etc. These are reproductions full of subtleties and details where the play with gloss and matte finishes has an essential role.

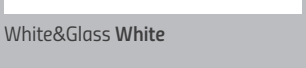
En el diseño de las colecciones hemos tenido en cuenta las últimas tendencias en color, pero a la vez hemos creado una gama tonal atemporal, que no pasa de moda. Cromatismos centrados en la simplicidad y la belleza, con la sobriedad y elegancia como cualidades que dominan las propuestas. Una gama de colores naturales capaz de crear superficies con personalidad única. El conjunto de las colecciones presenta una gran versatilidad matérica, pues se inspira y reproduce materiales como la madera, el cemento, la piedra natural, etc. Reproducciones llenas de sutilezas y detalles en las que los juegos de brillos y mates juegan un papel esencial.

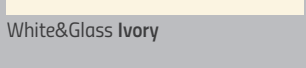
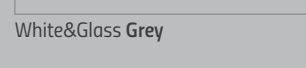
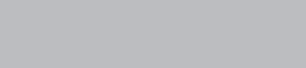
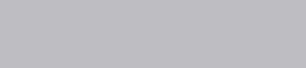
Bera&Beren	Lusitan & Catalan Limestone Ceramics Caliza Lusitana & Catalana Cerámica						* AVAILABLE BUSH HAMMERED * DISPONIBLE EN ABUJARDADO	
								
Floss	Natural Cement Ceramics Cemento Natural Cerámico					 		
								
Ground	Mixed Surfaces Ceramics Mezcla de Superficies Cerámico							
								
Gubi	Micro Cement Ceramics Micro Cemento Cerámico					 		
								
Lightwood	Natural Brushed Oak Ceramics Roble Natural Cepillado Cerámico							
								
Reverse	Quartzite Ceramics Cuarcita Cerámica							
Tesla	Natural Saw Marked Oak Ceramics Roble Aserrado Natural Cerámico							
Zero	Laminated Steel Ceramics Acero Laminado Cerámico							
Mayolica	Natural Mayolica Ceramics Mayólica Natural Cerámica							
White&Glass	Special Whites & Glass Ceramics Blancos Especiales & Vidrios Cerámicos							

COLOR BODY PORCELAIN / PORCELÁNICO MASA COLOREADA

WHITE BODY / PASTA BLANCA

Taking its name from the Portuguese and Catalan limestones, **Bera&Beren** is a minimalist and refined collection, included in **Contemporary Mixtures Surfaces**. It shows several finishes; Bera, with a semi-matte and even polishing; and Beren, which combines in perfect proportion mattes and subtle glosses in the grains and fossils spots. A unique quality through a careful selection of surfaces launched in 5 timeless stony colors with reduced shade variation. It is capable of creating sophisticated settings with large format pieces, like **90x90** or **60x180 cm**, in which its design quality goes hand in hand with the highest performance. Mechanical properties and durability of natural limestone, suitable for its use as floor covering, are enhanced.

Haciendo referencia a las piedras calizas de origen portugués y catalán, **Bera & Beren** es una colección de estilo minimalista y refinado, incluida en **Contemporary Mixtures Surfaces**. Se revela en diferentes acabados; Bera, con un acabado semimate y homogéneo; y Beren, que combina en perfecta proporción los mates y los tenues brillos en las zonas de granos y fósiles. Una calidad única a través de una cuidadosa selección de superficies que se presentan en 5 colores pétreos atemporales de reducida destonificación. Es capaz de crear espacios distinguidos con piezas de gran formato, como **90x90** ó **60x180 cm**, en las que la calidad de su diseño no está reñida con las más altas prestaciones, mejorando las propiedades mecánicas y la durabilidad de la caliza natural, idóneas para su uso en pavimento.



Bera White Bush Hammered / Abujardado 90x90 (36"x36")



Beren Light Grey 90x90 (36"x36") & Lightwood Cognac Mosaic 590 5x90 (2"x36")



Beren Biscuit 60x180 (24"x72")



Beren Dark Grey 90x90 (36"x36")



Beren Coal 90x90 (36"x36")

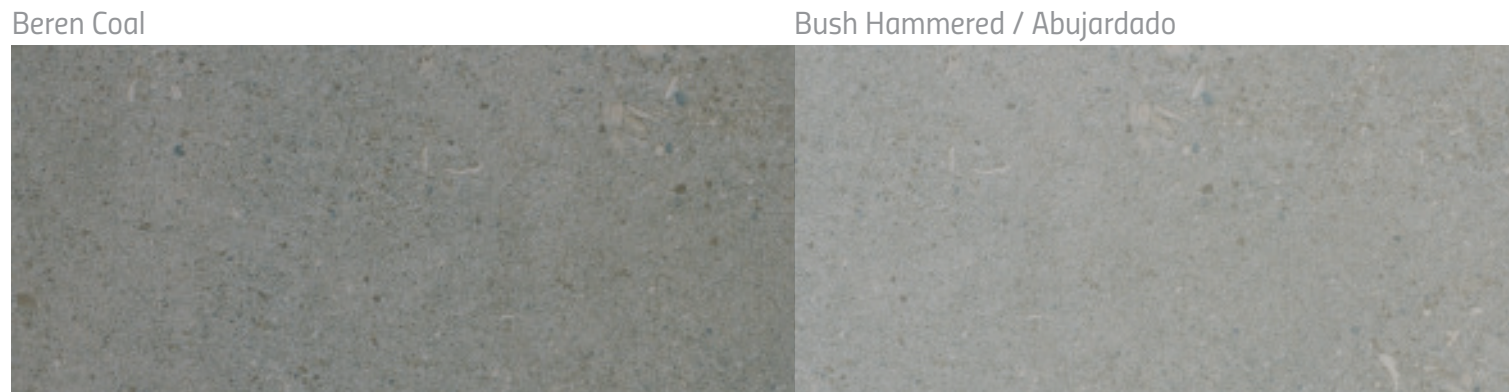
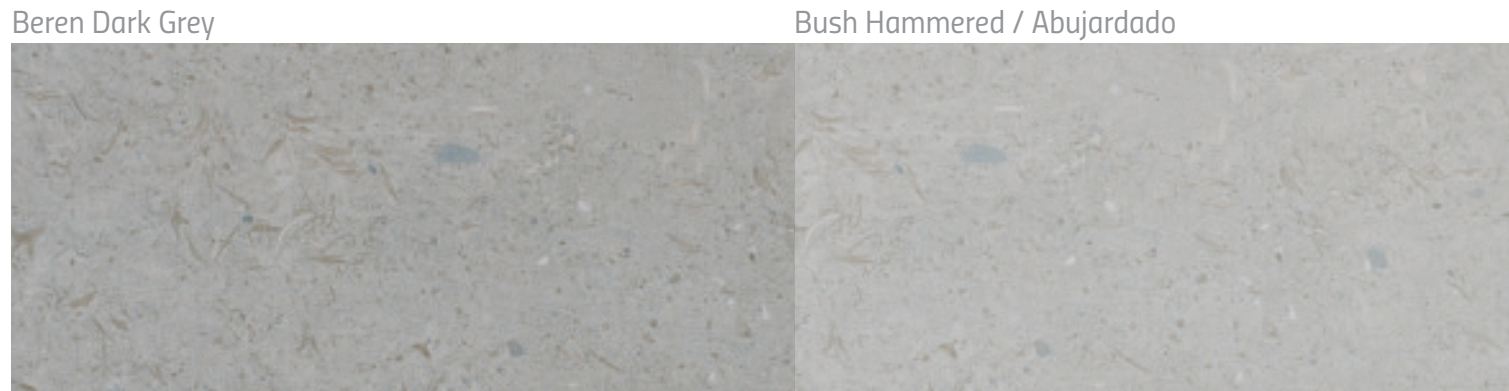
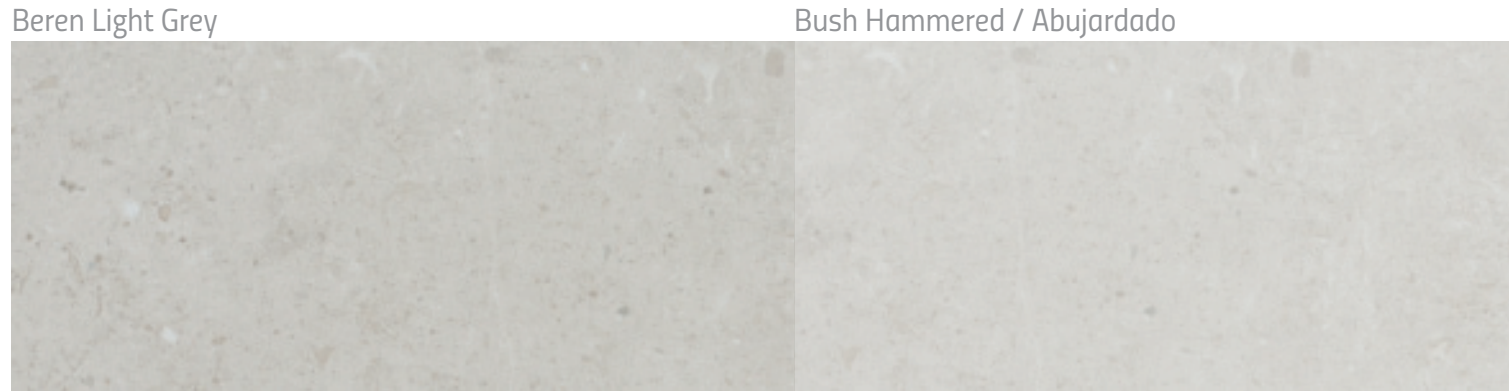
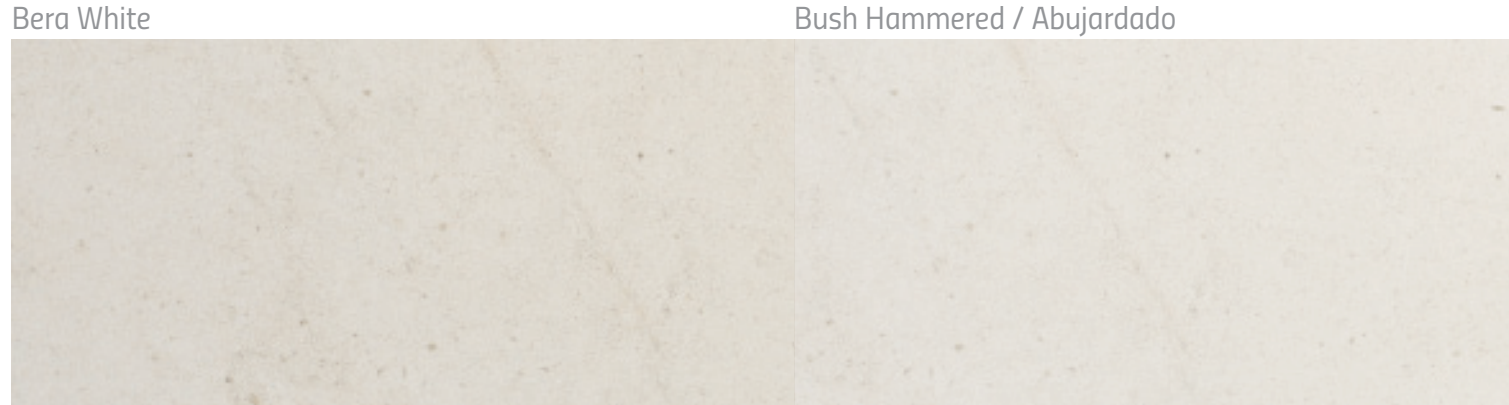

Bera&Beren

Lusitan & Catalan Limestone Ceramics
Caliza Lusitana & Catalana Cerámica



COLOR BODY PORCELAIN / PORCELÁNICO MASA COLOREADA
THICKNESS: 11 mm / RECTIFIED / DESTONIFIED V.2
ESPESOR: 11 mm / RECTIFICADO / DESTONIFICADO V.2

Nº DESIGNS BY FORMAT / Nº DE DISEÑOS POR FORMATO
60x180: **13** / 30x180: **26** / 90x90: **16** / 45x90: **32** / 60x60: **28** / 30x60: **56** / 10x60: **168** / 5x60: **168**

Formats & Sizes / Dimensiones & Formatos Scale Escala 1/20

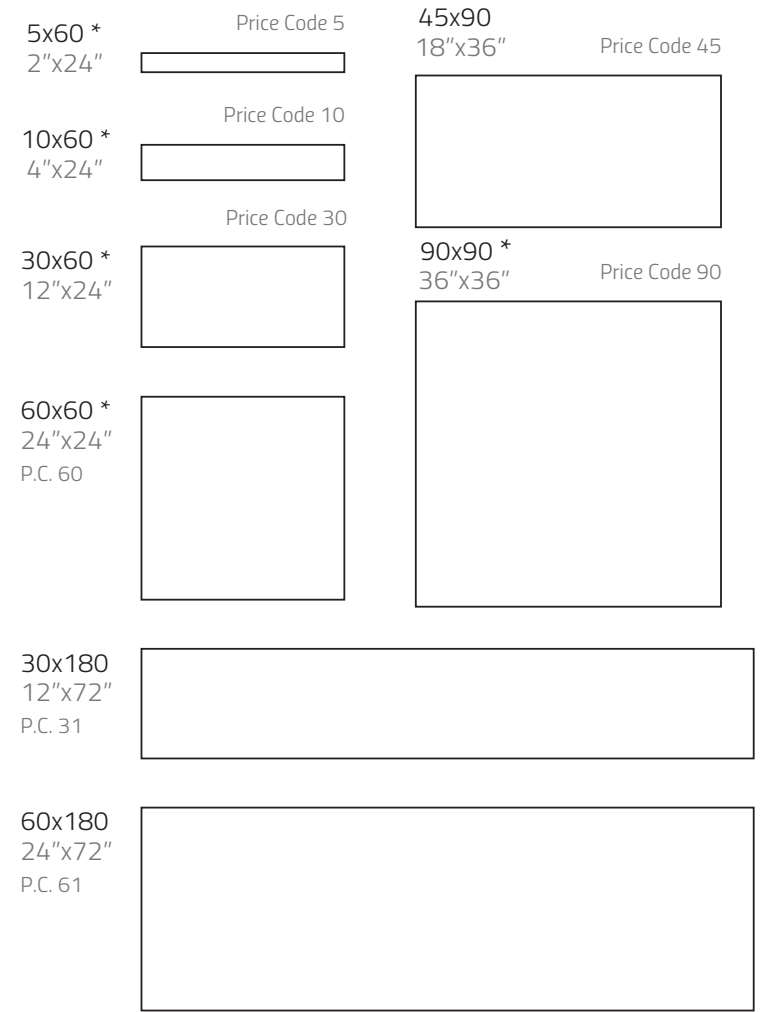

* Antislip Available / Disponible Antideslizante

Special Pieces / Piezas Especiales Scale Escala 1/20

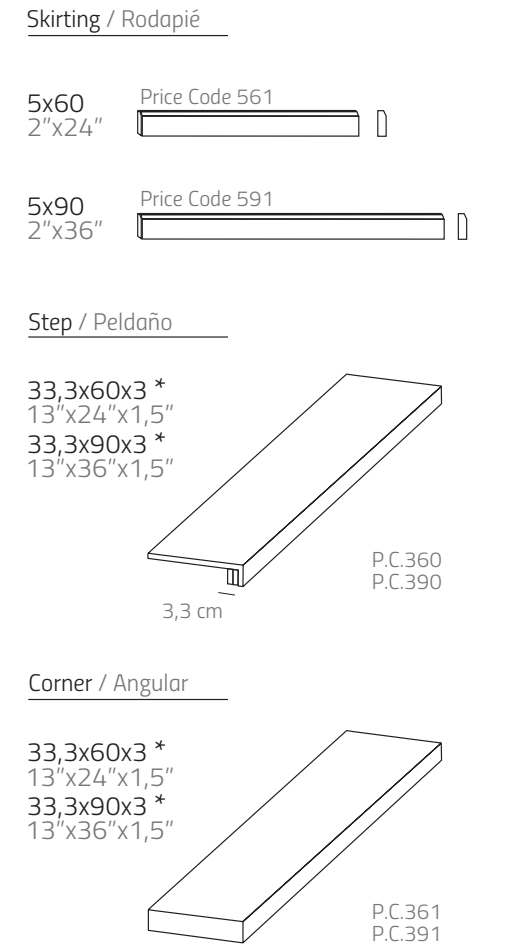

Complements / Complementos Scale Escala 1/20

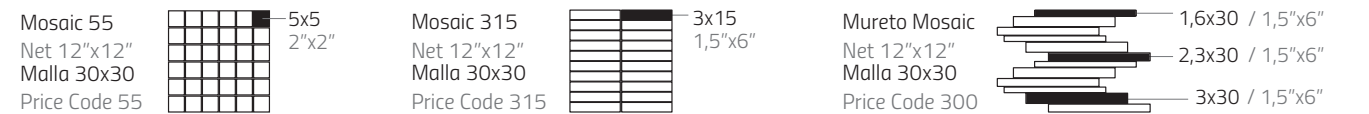

Floss finds its inspiration in concrete. This collection, part of **Contemporary Mixtures Surfaces**, goes back to the origins of industrial design, recovering raw concrete and stressing the result of an open air hardening. The irregular shade surface gives a unique character to the pieces, as it boosts the effect of salts through gloss and matte finishes which create areas full of details and plays of light. **Sizes up to 90x90 cm** and its technical features, together with its sober and contemporary colors, make this collection suitable for contract and outdoor projects.

La materialidad del cemento es la base de inspiración para **Floss**. Esta colección, enmarcada en **Contemporary Mixtures Surfaces**, vuelve a los orígenes del diseño industrial recuperando los cementos en crudo y enfatizado el resultado de un fraguado al aire. La superficie destonificada le aporta un carácter singular a las piezas resaltando el efecto de las sales a través de brillos y mates que configuran espacios llenos de sutilezas y juegos de luces. Los **tamaños de hasta 90x90 cm** y sus características técnicas junto a su cromatismo sobrio y contemporáneo hacen esta colección idónea para proyectos de contract y exteriores.



Floss Bone 90x90 (36"x36")

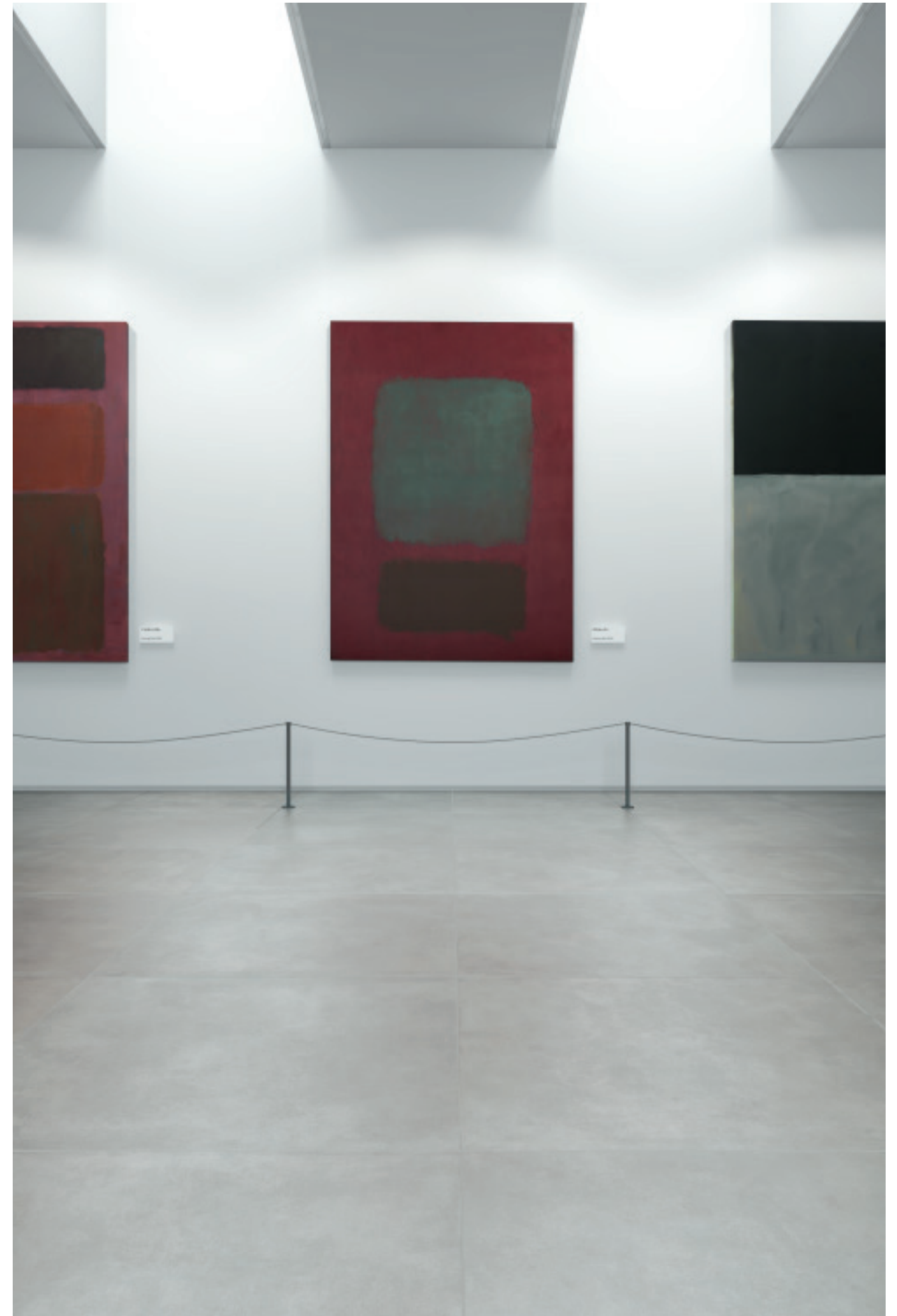

Floss Silver 90x90 (36"x36")



Floss Smoky 90x90 (36"x36") & Lightwood Ash 20x180 (8"x72")



Floss Graphite Mureto Mosaic 30x30 (12"x12")

Floss Bone



Floss Silver



Floss Smoky



Floss Graphite



Floss

Natural Cement Ceramics
Cemento Natural Cerámico



COLOR BODY PORCELAIN / PORCELÁNICO MASA COLOREADA
THICKNESS: 11 mm / RECTIFIED / DESTONIFIED V.3
ESPESOR: 11 mm / RECTIFICADO / DESTONIFICADO V.3

Nº DESIGNS BY FORMAT / Nº DE DISEÑOS POR FORMATO
90x90: **16** / 60x60: **28** / 30x60: **56** / 10x60: **168**

Formats & Sizes Dimensiones & Formatos

Scale Escala 1/20

10x60 *
4"x24"  Price Code 10

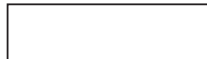
30x60 *
12"x24"  Price Code 30

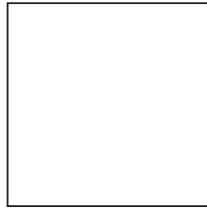
60x60 *
24"x24"  Price Code 60

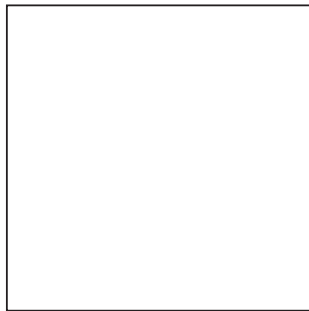
90x90 *
36"x36"  Price Code 90

* Antislip Available / Disponible Antideslizante

Special Pieces Piezas Especiales

Scale Escala 1/20

Skirting / Rodapié

5x60
2"x24"  Price Code 561

5x90
2"x36"  Price Code 591

Step / Peldaño

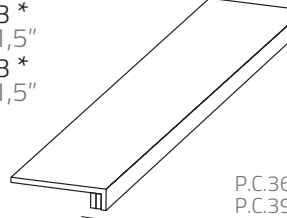
33,3x60x3 *
13"x24"x1,5"
33,3x90x3 *
13"x36"x1,5"
 P.C.360
P.C.390
3,3 cm

Corner / Angular

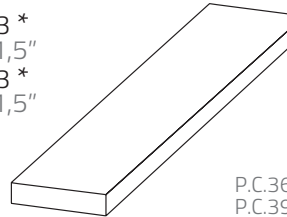
33,3x60x3 *
13"x24"x1,5"
33,3x90x3 *
13"x36"x1,5"
 P.C.361
P.C.391

Complements Complementos

Scale Escala 1/20

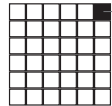
Mosaic 55
Net 12"x12"
Malla 30x30
Price Code 55  5x5
2"x2"

Mosaic 315
Net 12"x12"
Malla 30x30
Price Code 315  3x15
1,5"x6"

Mureto Mosaic
Net 12"x12"
Malla 30x30
Price Code 300  1,6x30 / 1,1"x6"
2,3x30 / 1,3"x6"
3x30 / 2,1"x6"

As a kind of visual interplay, **Ground** is a line that uses different material references to present a piece that is daring in its design but versatile in its use both indoors and outdoors, making it a perfect complement for the **Contemporary Mixture Surfaces** set of lines. Its pieces are filled with nuances through different texture designs, from the subtleties of the Loire Valley limestones to the texture of natural cement and the gentle gradations that provide references to terracotta. The result is a series of captivating pieces, with an exquisite and completely unique finish.

A modo de juego óptico, **Ground** es una colección que toma diferentes referentes matéricos para presentar una pieza atrevida en su propuesta, pero versátil en su aplicación tanto en interiores como en exteriores, lo que la convierte en un complemento perfecto para el conjunto de colecciones de **Contemporary Mixture Surfaces**. Sus piezas están repletas de matices a través de diferentes propuestas de texturas, desde las sutilezas de las piedras calizas del valle del Loira, hasta la textura del cemento natural y las suaves gradaciones que aportan las referencias al barro cocido. El resultado es una serie de piezas cautivadoras, con un acabado exquisito y completamente único.

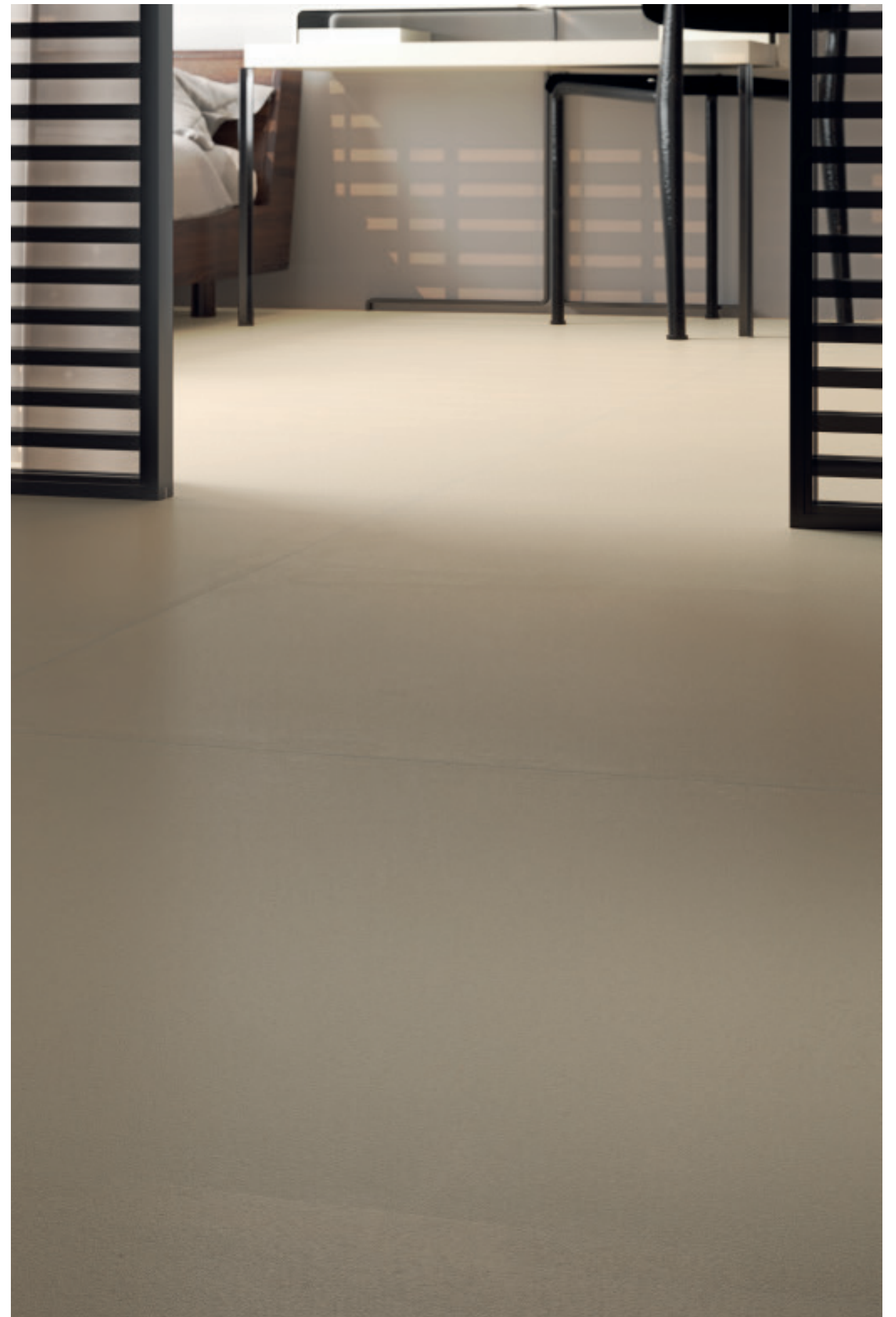



Ground Grey Moved Mosaic 30x30 (12"x12")



Ground Taupe 90x90 (36"x36") & Bera White 30x180 (12"x72") (Ventilated Facade)



Ground Anthracite 90x90 (36"x36")



Ground Black 90x90 (36"x36")

Ground Light



Ground Cream



Ground Grey



Ground Taupe



Ground Anthracite



Ground Black



Ground

Mixed Surface Ceramics
Mezcla de Superficies Cerámica



COLOR BODY PORCELAIN / PORCELÁNICO MASA COLOREADA
THICKNESS: 11 mm / RECTIFIED / DESTONIFIED V.1
ESPESOR: 11 mm / RECTIFICADO / DESTONIFICADO V.1

N° DESIGNS BY FORMAT / N° DE DISEÑOS POR FORMATO
90x90: **16** / 45x90: **32** / 60x60: **28** / 30x60: **56**

Formats & Sizes
Dimensiones & Formatos

Scale Escala 1/20

30x60
12"x24"



Price Code 30

60x60
24"x24"

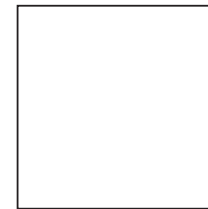

Price Code 60

45x90
18"x36"



Price Code 45

90x90
36"x36"

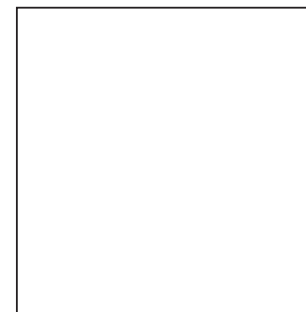

Price Code 90

Special Pieces
Piezas Especiales

Scale Escala 1/20

Skirting / Rodapié

5x60
2"x24"



Price Code 561

5x90
2"x36"

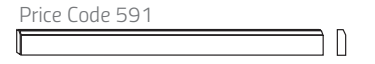

Price Code 591

Step / Peldaño

33,3x60x3
13"x24"x1,5"
33,3x90x3
13"x36"x1,5"

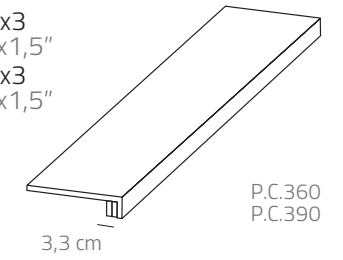

P.C.360
P.C.390

Corner / Angular

33,3x60x3
13"x24"x1,5"
33,3x90x3
13"x36"x1,5"

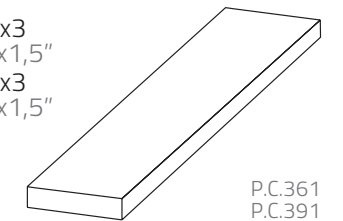

P.C.361
P.C.391

Complements
Complementos

Scale Escala 1/20

Hexa Mosaic
Net 12"x12"
Malla 30x30
Price Code 301

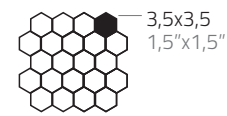

Mixed Mosaic
Net 12"x12"
Malla 30x30
Price Code 302

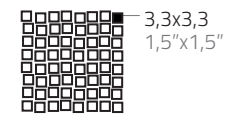

Spike Mosaic
Net 12"x18"
Malla 30x45
Price Code 303

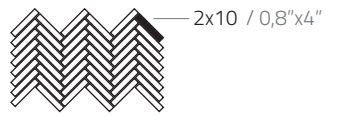

Gubi Collection has a sober style and can create minimalist environments. Inspired by the typical microcement polishing and smooth to touch, this collection combines a simple and elegant design with high functionality and **measures up to 90x90 and 60x180 cm**. The unevenness of natural stone, of the salts, and the watery effects turn into decorative resources, while the very nature of ceramics prevents problems derived from water absorption and efflorescences. Its color choice is a perfect combination of timelessness and trendy colors, which widens the combination capabilities of **Contemporary Mixtures Surfaces**.

La colección **Gubi** se enmarca en un estilo sobrio con gran capacidad para crear atmósferas minimalistas. Inspirado en el aspecto pulido propio del microcemento y suave al tacto, esta colección pone en práctica un diseño sencillo y elegante con una alta funcionalidad, y **dimensiones de hasta 90x90 y 60x180 cm**. Las heterogeneidades de la superficie natural, los efectos acuosos y de las sales se convierten en recurso decorativo, mientras que la propia naturaleza de la materia cerámica evita problemas de absorción y eflorescencias. La elección de su gama cromática establece un diálogo perfecto entre atemporalidad y colores de tendencia ampliando las posibilidades de combinación de **Contemporary Mixtures Surfaces**.





Gubi Anthracite 90x90 (36"x36") & Lightwood White 20x180 (8"x48")



Gubi Taupe 90x90 (36"x36")

Gubi Light



Gubi Cloud



Gubi Taupe



Gubi Anthracite



Gubi

Micro Cement Ceramics
Micro Cemento Cerámico



COLOR BODY PORCELAIN / PORCELÁNICO MASA COLOREADA
THICKNESS: 11 mm / RECTIFIED / DESTONIFIED V.2
ESPESOR: 11 mm / RECTIFICADO / DESTONIFICADO V.2

N° DESIGNS BY FORMAT / N° DE DISEÑOS POR FORMATO
60x180: **13** / 30x180: **26** / 90x90: **16** / 45x90: **32** / 60x60: **28** / 30x60: **39** / 10x60: **39**

Formats & Sizes Dimensiones & Formatos

Scale Escala 1/20

45x90
18"x36"



Price Code 45

90x90 *
36"x36"

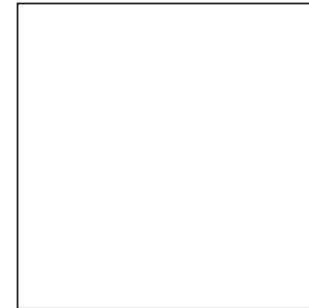

Price Code 90

30x180
12"x72"



Price Code 61

60x180
24"x72"

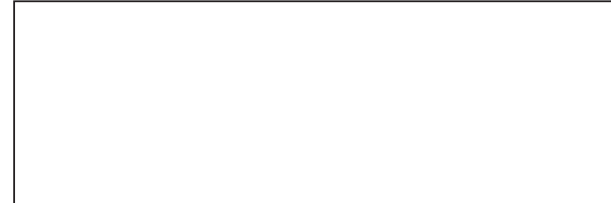

10x60 *
4"x24"

Price Code 10

30x60 *
12"x24"

Price Code 30

60x60 *
24"x24"

Price Code 60

Price Code 31

* Antislip Available / Disponible Antideslizante

Special Pieces Piezas Especiales

Scale Escala 1/20

Skirting / Rodapié

5x60
2"x24"



Price Code 561

5x90
2"x36"

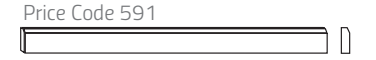

Price Code 591

Step / Peldaño

33,3x60x3 *
13"x24"x1,5"
33,3x90x3 *
13"x36"x1,5"

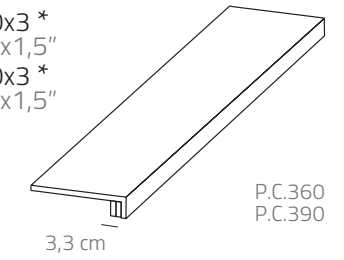

P.C.360
P.C.390

Corner / Angular

33,3x60x3 *
13"x24"x1,5"
33,3x90x3 *
13"x36"x1,5"

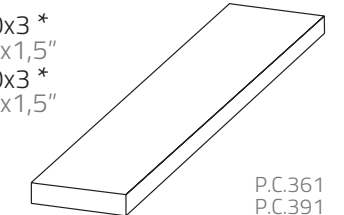

P.C.361
P.C.391

Complements Complementos

Scale Escala 1/20

Mosaic 55
Net 12"x12"
Malla 30x30
Price Code 55

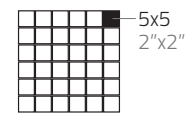

Mosaic 315
Net 12"x12"
Malla 30x30
Price Code 315



Mureto Mosaic
Net 12"x12"
Malla 30x30
Price Code 300

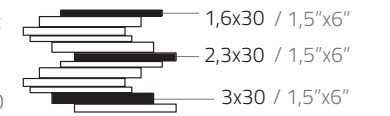

Lightwood | Natural Brushed Oak Ceramics
Roble Natural Cepillado Cerámico

Part of our proposal **Contemporary Mixtures Surfaces**, a design emphasizing the gorgeous nature of oakwood, **Lightwood** Collection clearly follows Scandinavian style, mimicking a carefully brushed surface. In these pieces, a subtle interpretation of the wood knots is achieved, with a matte, silky finish, which results in a harmonious and elegant look. The collection features 6 natural colors. It includes **lengths up to 180 cm**, with huge aesthetic and creative possibilities. All in all, it does not give up the hardness, resistance and ease of maintenance of ceramics, thus offering optimal performances compared to the natural product.

Formando parte de **Contemporary Mixtures Surfaces**, con un diseño que enfatiza la impactante naturaleza de las maderas nobles de roble, la colección **Lightwood** es de corte claramente escandinavo, mimetizando una superficie cuidadosamente cepillada. En estas piezas se consigue una sutil interpretación de los nudos de la madera con un acabado mate y sedoso que otorga un aspecto armónico y elegante al resultado. La colección se compone de 6 colores naturales con **largos de hasta 180 cm** con amplias posibilidades estéticas y creativas. Todo ello sin renunciar a la dureza, resistencia y facilidad de mantenimiento del material cerámico, ofreciendo óptimas prestaciones respecto al producto natural.



Lightwood White 20x180 (8"x72") & Floss Graphite 90x90 (36"x36")



Lightwood Sand 20x180 (8"x72")



Lightwood Canella 20x180 (8"x72") & Ground Grey 90x90 (36"x36")

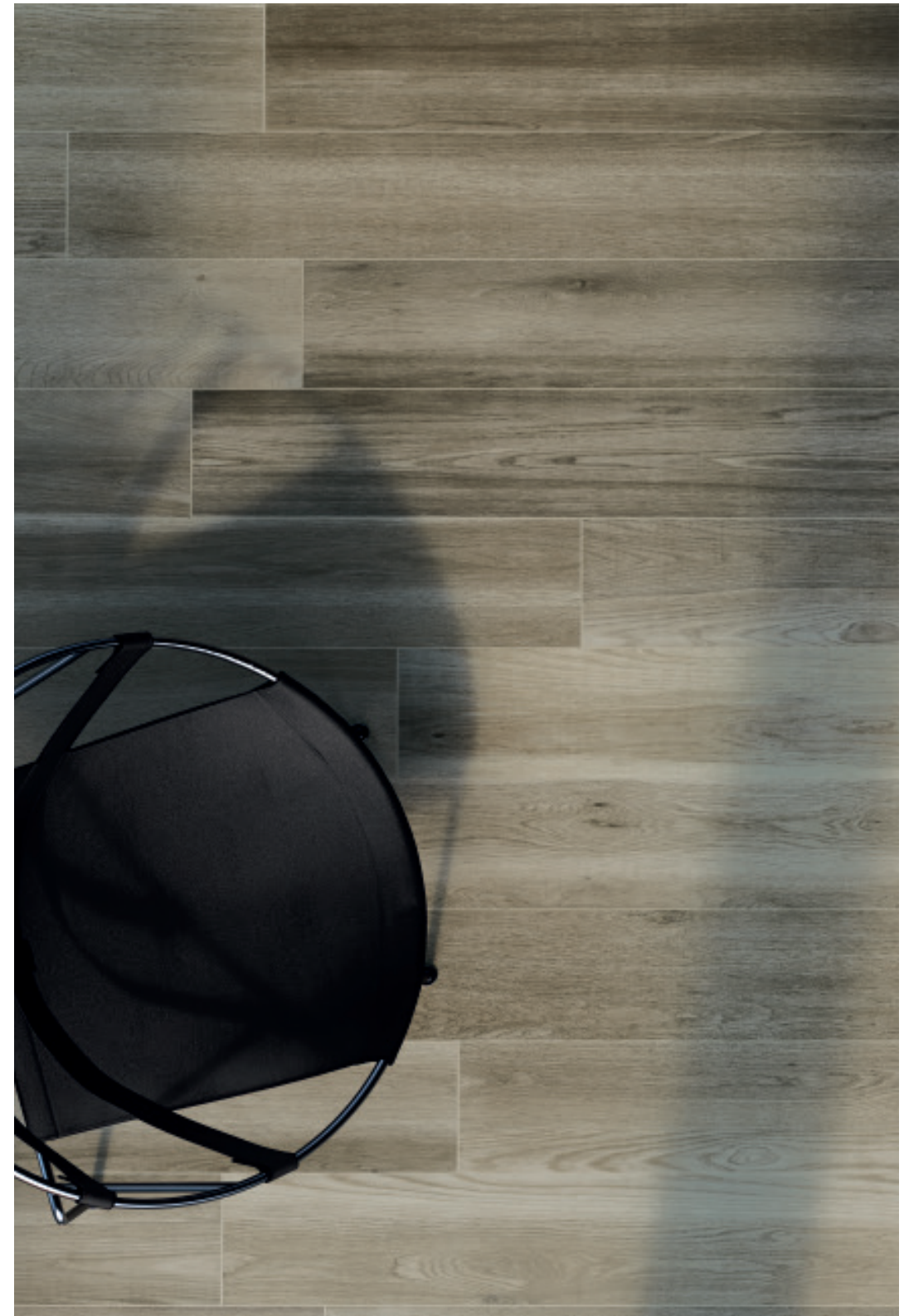

Lightwood Ash 20x180 (8"x72")

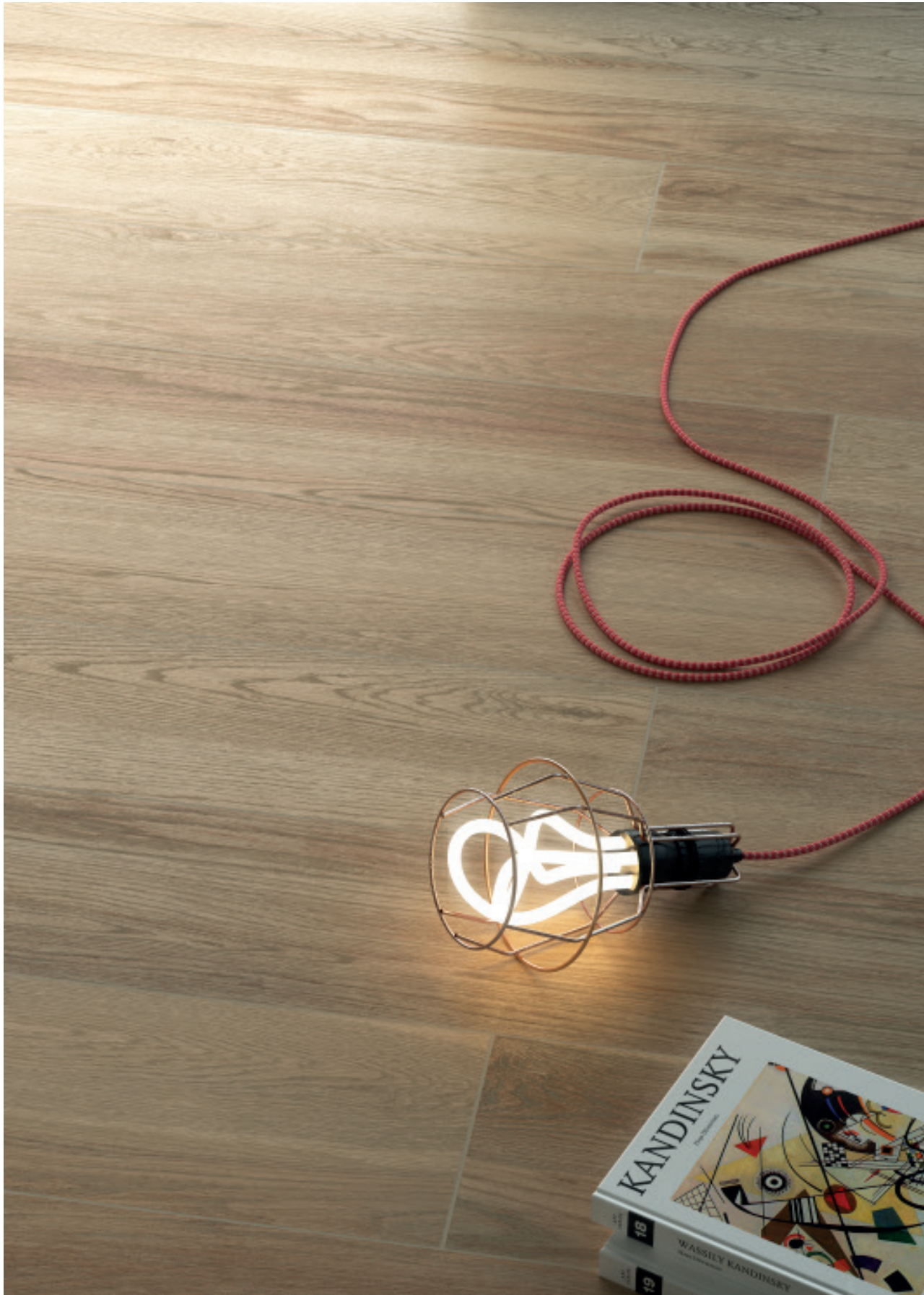

Lightwood Cognac 20x180 (8"x72")



Lightwood Brown 20x180 (8"x72")



Lightwood Sand 20x180 (24"x48") & Ground Light 90x90 (36"x36")

Lightwood White



Lightwood Sand



Lightwood Canella



Lightwood Cognac



Lightwood Ash



Lightwood Brown



Lightwood

Natural Brushed Oak Ceramics
Roble Natural Cepillado Cerámico



COLOR BODY PORCELAIN / PORCELÁNICO MASA COLOREADA
THICKNESS: 11 mm / RECTIFIED / DESTONIFIED V.3
ESPESOR: 11 mm / RECTIFICADO / DESTONIFICADO V.3

N° DESIGNS BY FORMAT / N° DE DISEÑOS POR FORMATO
60x180: **13** / 20x180: **39** / 20x120: **39** / 15x90: **52**

Formats & Sizes
Dimensiones & Formatos

Scale Escala 1/20

Special Pieces
Piezas Especiales

Scale Escala 1/20

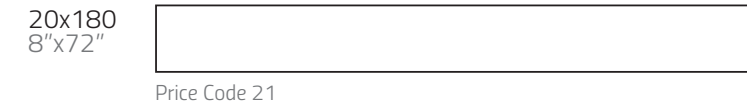

* Antislip Available / Disponible Antideslizante

Skirting / Rodapié



Step / Peldaño



Corner / Angular

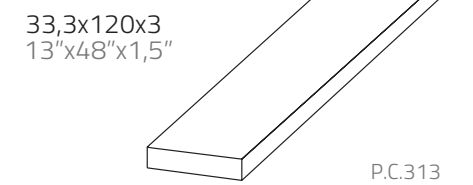

Complements
Complementos

Scale Escala 1/20

Mosaic 330
3x30
1,5"x12"
Price Code 330



Net 12"x12"
Malla 30x30

Mosaic 590
5x90
2"x36"
Price Code 590

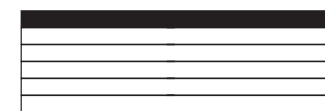

Net 12"x36"
Malla 30x90

Tesla is inspired by the sawn natural oak and it is produced in large **formats up to 180 cm**. It evenly combines the industrial looks from its slight stripping with the wood's organic properties through a smooth and elegant finish of the veins, enhancing the contrast between matte and gloss textures. The collection, as part of **Contemporary Mixtures Surfaces**, features a new, contemporary language. With 6 single color shades of exquisitely colored wood, it offers a minimalist and avantgarde result. Its durability allows to reduce its maintenance and preservation costs.

Tesla está inspirada en el roble natural aserrado y se materializa en grandes **formatos de hasta 180 cm**. Combina de forma equilibrada el aspecto industrial que le proporciona el sutil decapado, con las propiedades orgánicas de la madera a través de un acabado suave y elegante de la malla, enfatizando el contraste de texturas en mate y brillo. La colección, integrada en **Contemporary Mixtures Surfaces** se caracteriza por un lenguaje nuevo y contemporáneo. Con 6 tonalidades monocolor de madera exquisitamente coloreada, ofrece un resultado minimalista y de vanguardia. La durabilidad del material permite reducir su coste de mantenimiento y conservación.





Tesla Fog 20x180 (8"x72") & Ground Anthracite 90x90 (36"x36")



Tesla Tobacco 20x180 (8"x72")



Tesla Taupe 20x180 (8"x72") (Step Tile)



Tesla Carbon 20x180 (8"x72") & Beren Dark Grey AS 90x90 (36"x36")

Tesla Artic



Tesla Vanilla



Tesla Fog



Tesla Tobacco



Tesla Taupe

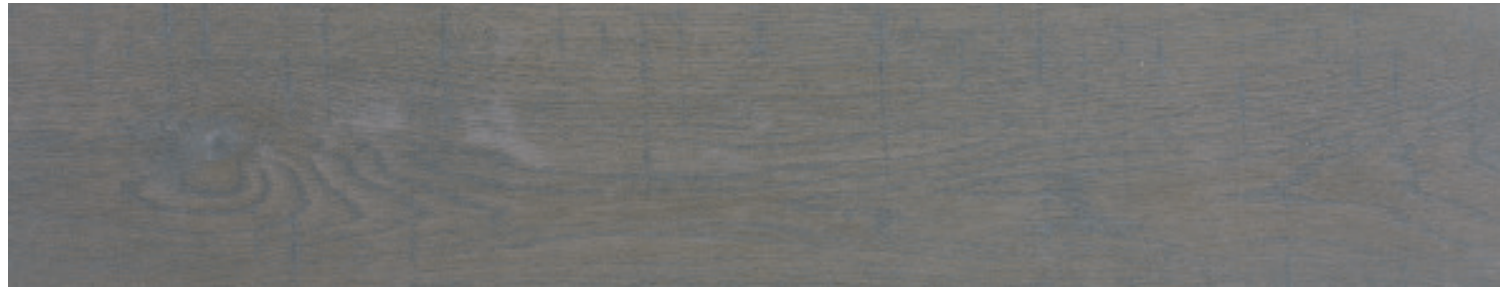

Tesla Carbon

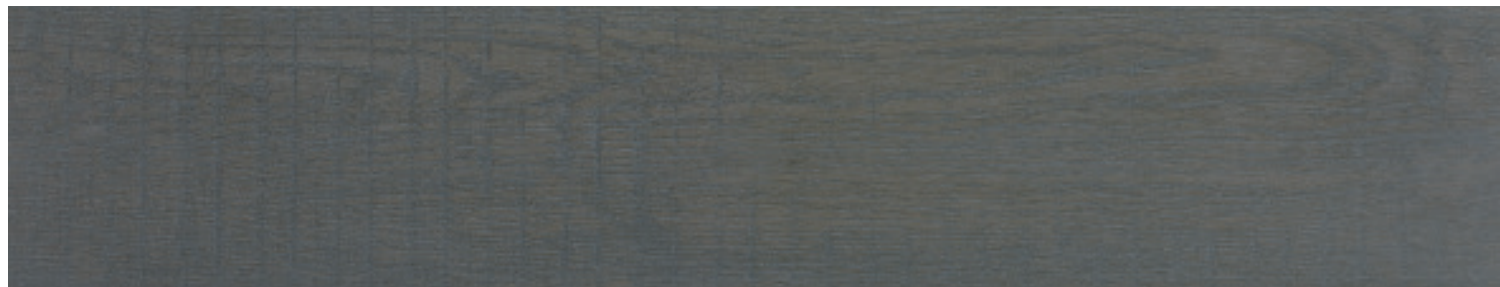

Tesla

Natural Saw Marked Oak Ceramics
Roble Aserrado Natural Cerámico



COLOR BODY PORCELAIN / PORCELÁNICO MASA COLOREADA
THICKNESS: 11 mm / RECTIFIED / DESTONIFIED V.2
ESPESOR: 11 mm / RECTIFICADO / DESTONIFICADO V.2

Nº DESIGNS BY FORMAT / Nº DE DISEÑOS POR FORMATO
60x180: **13** / 20x180: **39** / 20x120: **39**

Formats & Sizes
Dimensiones & Formatos

Scale Escala 1/20

Special Pieces
Piezas Especiales

Scale Escala 1/20

20x120 *
8"x48"



Price Code 20

5x120
2"x48"

Price Code 521

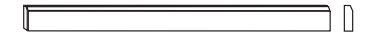

Skirting / Rodapié

Step / Peldaño

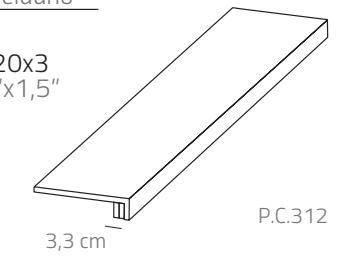

P.C.312

20x180
8"x72"



Price Code 21

60x180
24"x72"



Price Code 61

Corner / Angular

33,3x120x3
13"x48"x1,5"

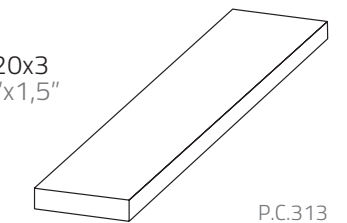

P.C.313

* Antislip Available / Disponible Antideslizante

Complements
Complementos

Scale Escala 1/20

Mosaic 330
3x30
1,5"x12"
Price Code 330



Net 12"x12"
Malla 30x30

Mosaic 590
5x90
2"x36"
Price Code 590

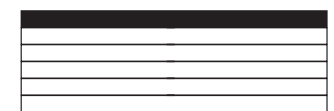

Net 12"x36"
Malla 30x90

Contemporary Mixtures Surfaces adopt a new material personality in **Zero**. With a contrast metallic finish and wide graphic diversity, the collection is useful and contemporary. Multifaceted and suitable for professional environments as well as for cosmopolitan homes, Zero is a tribute to versatility. Its pieces adapt to indoors and outdoors, floors and walls, and come in large **formats up to 60x120 cm**. Its studied, light and dark metallic shades are an answer to the different architectural solutions.

Las superficies de **Contemporary Mixtures Surfaces** adquieren una nueva personalidad metálica en **Zero**. Con un acabado metálico de contraste y gran diversidad gráfica, la colección es práctica y actual. Polifacética y válida para integrarse tanto en espacios profesionales como en interiores domésticos de corte cosmopolita, Zero es una celebración a la versatilidad. Sus piezas se adaptan a interiores y exteriores, suelos y paredes y se presenta en grandes **formatos de hasta 60x120 cm**. Sus estudiadas tonalidades metálicas claras y oscuras, responden a las diferentes soluciones arquitectónicas.



Zero Light Metallic 45x90 (18"x36")



Zero Dark Metallic 60x120 (24"x48") & Mosaic 55 5x5 (2"x2") & White&Glass Grey 40x120 (16"x48")

Zero Light Metallic



Zero Dark Metallic



Zero

Laminated Steel Ceramics
Acero Laminado Cerámico



COLOR BODY PORCELAIN / PORCELÁNICO MASA COLOREADA
THICKNESS: 11 mm / RECTIFIED / DESTONIFIED V.2
ESPESOR: 11 mm / RECTIFICADO / DESTONIFICADO V.2

N° DESIGNS BY FORMAT / N° DE DISEÑOS POR FORMATO
60x120: 32 / 45x90: 32

Formats & Sizes
Dimensiones & Formatos

Scale Escala 1/20

45x90 *
18"x36"

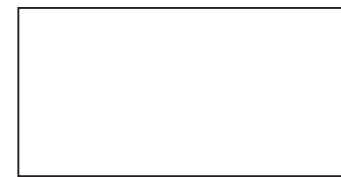

Price Code 45

60x120
24"x48"



Price Code 62

* Antislip Available / Disponible Antideslizante

Special Pieces
Piezas Especiales

Scale Escala 1/20

Skirting / Rodapié

5x90
2"x36"



Price Code 591

5x120
2"x48"

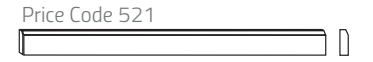

Price Code 521

Step / Peldaño

33,3x90x3 *
13"x36"x1,5"
33,3x120x3
13"x48"x1,5"

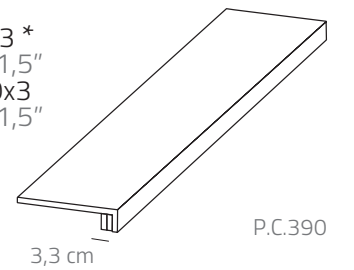

P.C.390

3,3 cm

Corner / Angular

33,3x90x3 *
13"x36"x1,5"
33,3x120x3
13"x48"x1,5"

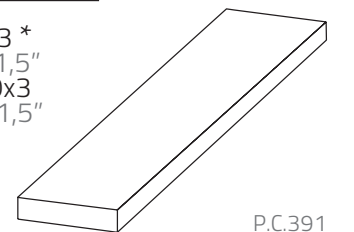

P.C.391

Complements
Complementos

Scale Escala 1/20

Mosaic 55
Net 12"x12"
Malla 30x30
Price Code 55

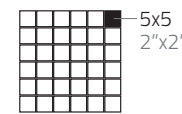

5x5
2"x2"

Mosaic 315
Net 12"x12"
Malla 30x30
Price Code 315



3x15
1,5"x6"

Mayolica springs from the connection between tradition and ceramics' historical roots; a white body wall tile collection in **small 7.5x15 and 7.5x30 cm formats** for indoors. It is a contemporary revisit of the manual glazed terracottas, capable of reconnecting with memory. Its design is the result of the search for industrial excellence inspired by the typical imperfect beauty of craftsmanship. With a rich color palette with glossy and transparent glazings, it offers a brilliant counterpoint, full of character, to the rest of **Contemporary Mixtures Surfaces** collections, with a result that provides beauty and closeness.

De la conexión con la tradición y las raíces históricas de la cerámica surge **Mayólica**, una colección de pasta blanca para revestimiento de interiores en **pequeños formatos de 7,5x15 y 7,5x30 cm**. Supone una reinterpretación contemporánea de las terracotas esmaltadas manuales capaces de reconectar con la memoria. Su diseño es fruto de la búsqueda de la excelencia industrial inspirada en la belleza imperfecta propia de la artesanía. Con una rica paleta de color con vidriados brillantes y transparentes, ofrece un contrapunto luminoso y lleno de personalidad para el resto de la colección **Contemporary Mixtures Surfaces** con un resultado que aporta belleza y cercanía.



Mayolica Matt White 7,5x15 (3"x6")



Mayolica White 7,5x30 (3"x6") & Gubi Cloud 90x90 (36"x36") & Gubi Cloud 60x180 (24"x72") (Countertop)



Mayolica Soft Grey Mix Formats & Tesla Tobacco 20x120 (8"x48")



Mayolica Ivory 7,5x30 (3"x66") & Gubi Cloud 90x90 (36x36)



Mayolica Taupe 7,5x30 (3"x6") & Tesla Artic 20x120 (8"x48") (Floor & Countertop)



Mayolica Grey Mix Formats & Lightwood Canella 20x180 (8"x72")

Mayolica White



Mayolica Matt White

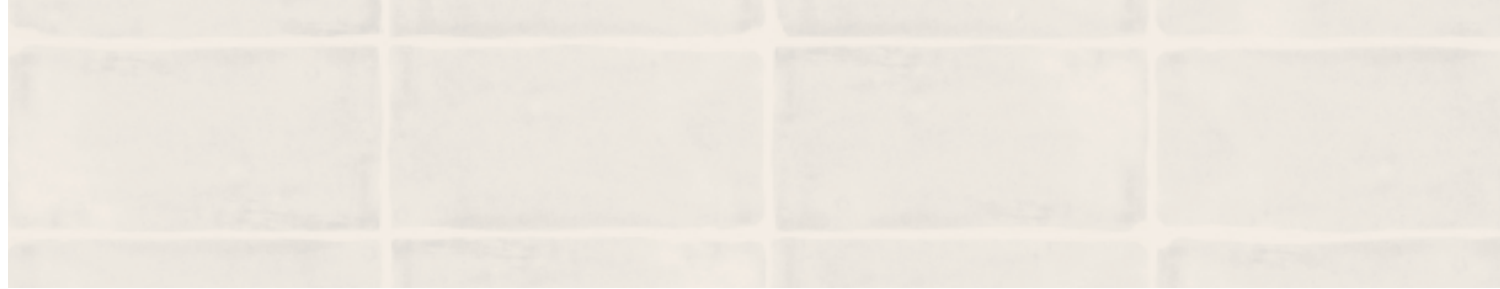

Mayolica Ivory



Mayolica Soft Grey



Mayolica Grey



Mayolica Taupe

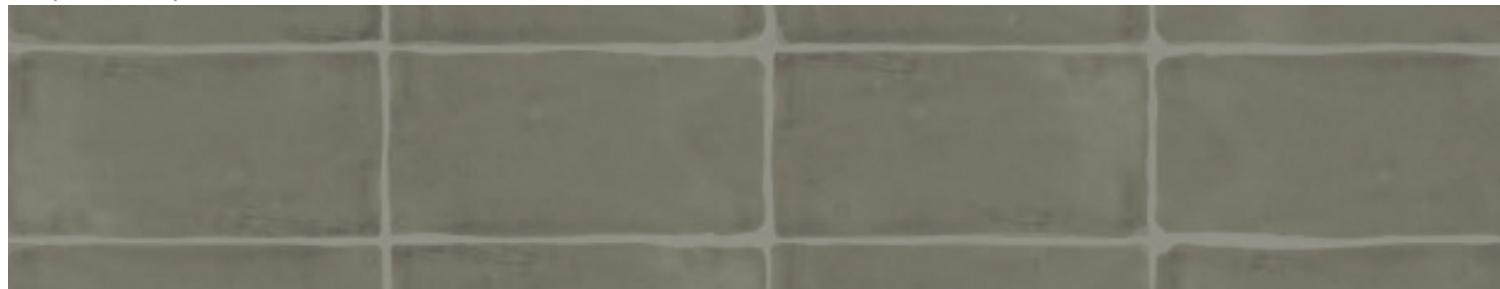

Mayolica

Natural Mayolica Ceramics
Mayólica Natural Cerámica



WHITE BODY / PASTA BLANCA
THICKNESS: 9,8 mm / NON RECTIFIED / DESTONIFIED V.2
ESPESOR: 9,8 mm / NO RECTIFICADO / DESTONIFICADO V.2

Nº MOULDS BY FORMAT / Nº DE MOLDES POR FORMATO
7,5x15: 4 / 7,5x30: 2

Formats & Sizes
Dimensiones & Formatos

Scale Escala 1/20

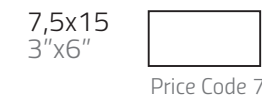

Formats & Sizes
Dimensiones & Formatos

Scale Escala 1/20

7,5x15

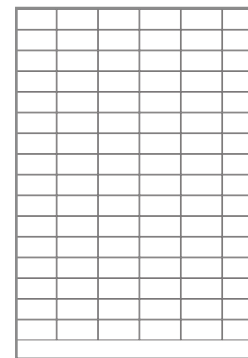

7,5x30

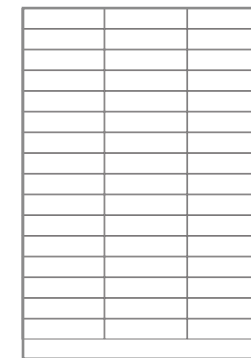

7,5x15 & 7,5x30

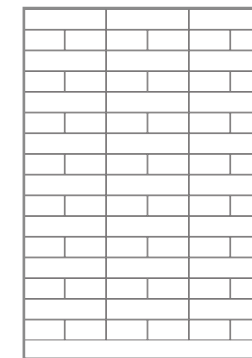

7,5x15 & 7,5x30

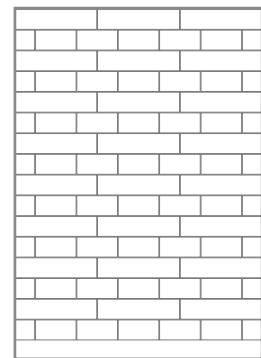

7,5x15

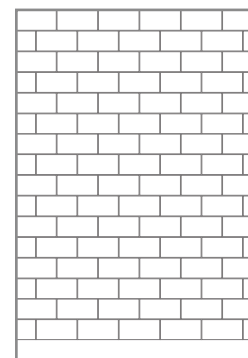

7,5x30

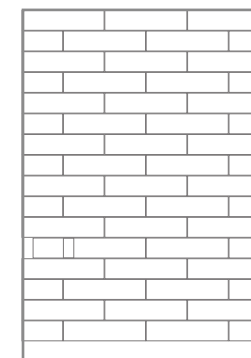

7,5x15 & 7,5x30

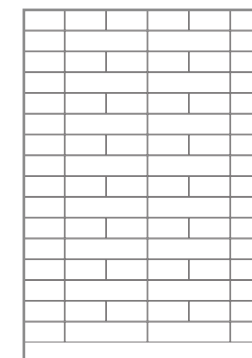

7,5x15 & 7,5x30

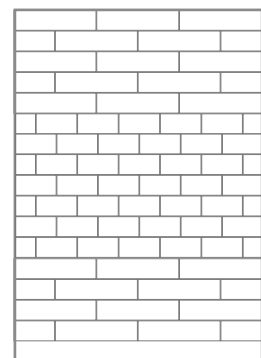

White&Glass perfectly adapts to current aesthetic and formal needs. Its even, glazed pieces show sophisticated and flawless finishes, either glossy or matte. They represent the key principle of luxury being found in simplicity. An essential **white body product of up to 120 cm**, designed for covering with two pieces the height of contemporary bathrooms and kitchens. Its color range stresses the commitment with ceramics and is an ideal complement for the rest of **Contemporary Mixtures Surfaces** collections, offering a whole package for interior designers.

White&Glass se adapta a la perfección a las necesidades estéticas y formales del momento. Sus piezas homogéneas y vitrificadas presentan sofisticados e impecables acabados en brillo o mate. Representan la máxima de que el lujo está contenido en la sencillez. Un producto esencial de **pasta blanca de hasta 120 cm**, ideado para modular en dos piezas la altura de los baños y cocinas actuales. Su gama cromática remarca el compromiso con el material cerámico y es un complemento ideal para el resto de las colecciones de **Contemporary Mixtures Surfaces**, brindando una oferta integral que da respuesta al diseño de interiores.



White&Glass White 40x120 (16"x48") & Gubi Anthracite 90x90 (36"x36")



White&Glass White 40x120 (16"x48") & Floss Silver 90x90 (36"x36")



White&Glass Ivory 40x120 (16"x48") & Tesla Tobacco 60x180 (24"x72") & Mosaic 5x90 (2"x36")



White&Glass Grey 40x120 (16"x48") & Lightwood Cognac 60x180 (24"x72") (Countertop)

White&Glass White

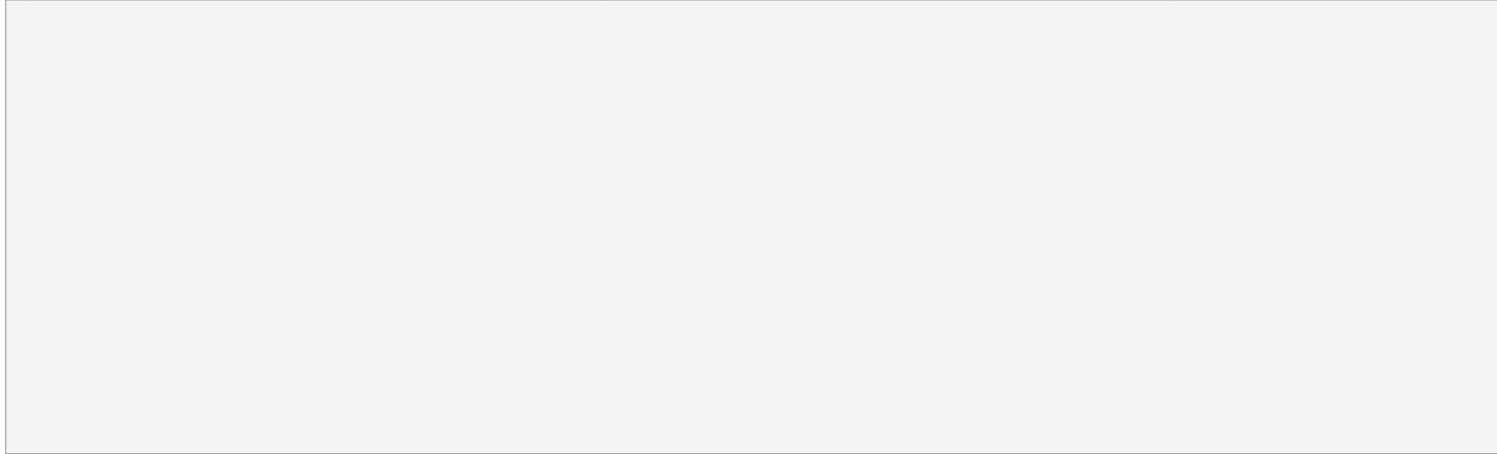

White&Glass Matt White



White&Glass Ivory

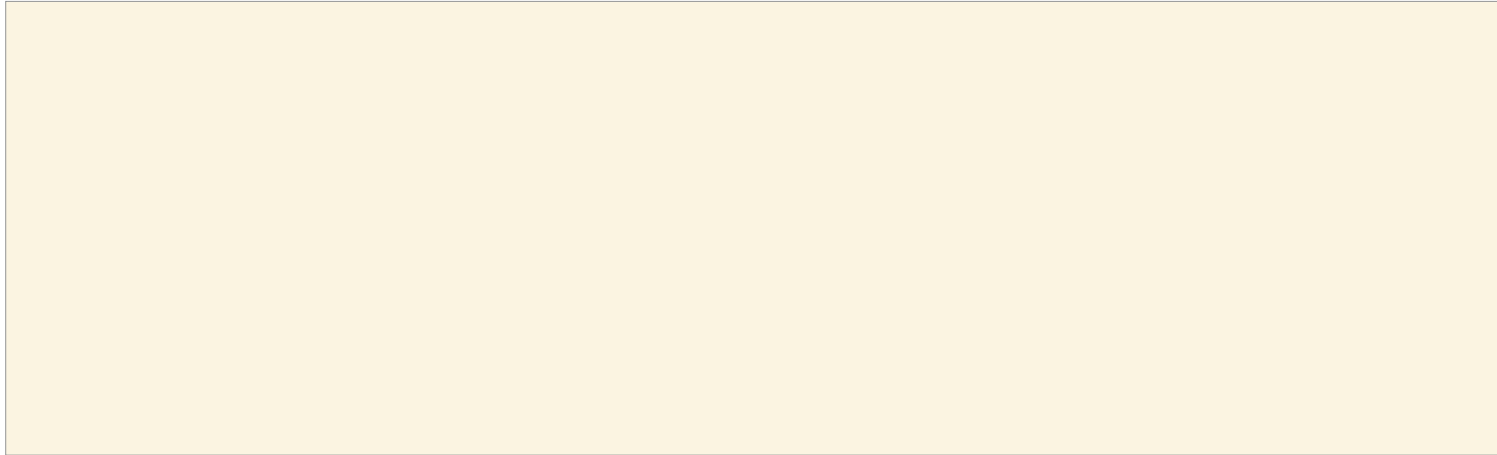

White&Glass Grey



White&Glass

Special Whites & Glass Ceramics
Blancos Especiales & Vidrios Cerámicos



WHITE BODY / PASTA BLANCA
THICKNESS: 11 mm / NON RECTIFIED / DESTONIFIED V.0
ESPESOR: 11 mm / NO RECTIFICADO / DESTONIFICADO V.0

Nº MOULDS BY FORMAT / Nº DE MOLDES POR FORMATO
40x120: 1

Formats & Sizes
Dimensiones & Formatos

Scale Escala 1/20

40x120
16"x48"



Price Code 40



Living works under the criteria of environmental respect, occupational safety and health, and quality, as principles of our company culture. This philosophy has led us to be part of the **Green Building Council**, a non-profit association made up of companies working for our environments to be sustainable, responsible, and healthful for people. We safeguard the safety at work by training our staff in safety and environmental protection aspects. Our environmental management has obtained the **ISO 14001 - AENOR**. We work to be sustainable in different fields: Sustainable energy: we save energy in the phase of soil atomization, reusing the combustion gases released by the turbines in cogeneration. We have minimized the energy use when kilning materials in the piece pre-drying phase and when heating the air required for combustion. Water saving: we reuse the water coming from the grinding section for cleaning the glazing section. This residual water, together with the sludge, have a second use in the slip that is later atomized. Containers and packaging: we use enclosing-type cardboard boxes which save material. In addition, all our containers and packaging are recyclable. Reuse of materials: during the production cycle we reuse both the excess from non-kilned materials as the excess from kilned ones coming from the grinding section, which are used in the slips.

Desde Living trabajamos bajo criterios de respeto al medio ambiente, la seguridad y salud en el trabajo. Esta filosofía nos ha llevado a formar parte del **Green Building Council**, una asociación sin ánimo de lucro formada por empresas que trabajamos para que nuestros entornos sean sostenibles y responsables. Velamos por la seguridad en el ámbito laboral formando a nuestro personal en aspectos de seguridad y medio ambiente. En nuestras plantas de producción nuestra gestión medioambiental ha culminado en la obtención de la certificación **ISO 14001 - AENOR**. Sostenibilidad energética: ahorramos energía en la fase de atomización de la tierra, reutilizando los gases de combustión liberados por las turbinas en la cogeneración. Hemos minimizado el uso energético aprovechando los gases emitidos durante la cocción de los materiales para ser utilizados en la fase de presecado de las piezas y en el calentamiento del aire necesario para la combustión. Ahorro de agua: reutilizamos el agua procedente de la sección de rectificado para la limpieza de la sección de esmaltado. Estas aguas residuales, junto con los lodos, son utilizadas para elaborar parte de la barbotina que posteriormente es atomizada. Reutilización de materias: durante el ciclo productivo reutilizamos tanto los sobrantes de los materiales no cocidos, como de los cocidos procedentes de la sección de rectificado que son usados en las barbotinas. Todos nuestros envases y embalajes son reciclables.



Green Building Member / Miembro del Green Building Council
 Environmental Management System ISO 14001 / Sistema Productivo con Certificado Ambiental ISO 14001
 Use of Certificate FSC Paper / Uso de Papel con Certificado FSC.

Our solutions include customized steps from our mass colored porcelain lines. It is a product capable of adjusting to any type of stairs: catalan stair, floating stairs, turning floating stairs. The measurements and data are recorded in a simple form, collecting the necessary information for cutting the steps.

Nuestras soluciones incluyen peldaños a medida de nuestras colecciones de porcelánico de masa coloreada. Un producto a medida capaz de adecuarse a cualquier tipo de escalera: escalera catalana, escalera colgada, de ojo colgada... Los datos y medidas se anotan en un sencillo formulario que recoge toda la información necesaria para el corte de los peldaños.

SPECIFICATIONS
ESPECIFICACIONES

COLOR BODY PORCELAIN / PORCELÁNICO MASA COLOREADA

RECTIFIED / RECTIFICADO // THICKNESS : 11 mm / ESPESOR: 11 mm

REINFORCEMENT SIDES IN NORMAL OR TRIPLE / REFUERZO DE CANTOS EN NORMAL O TRIPLE

The versatility of our mass colored porcelain pieces allows us to manufacture countertops for kitchens or bathrooms increasing the decorative options of our lines. The format is customized according to the needs of each client. The measurements and data are recorded in a simple collecting the necessary information for the production of the countertop. (* view Order Form Plan)

La versatilidad de nuestras piezas porcelánicas de masa coloreada, permite elaborar encimeras para cocinas o baños aumentando las opciones decorativas de las colecciones. El formato se personaliza en función de las necesidades de cada cliente. Los datos y medidas se anotan en un sencillo formulario que recoge toda la información necesaria para la producción de la encimera. (* Ver Hoja de Pedido)

SPECIFICATIONS
ESPECIFICACIONES

COLOR BODY PORCELAIN / PORCELÁNICO MASA COLOREADA

RECTIFIED / RECTIFICADO // THICKNESS : 11 mm / ESPESOR: 11 mm

REINFORCEMENT FIBERGLASS POLYESTER RESIN / REFUERZO DE FIBRA DE VIDRIO CON RESINA DE POLIÉSTER

STEP TILES EXAMPLE
EJEMPLO DE PELDAÑOS



DOWNLAD SHEET ON THE WEB
DESCARGA LA HOJA DE PEDIDO EN LA WEB

Livingceramics ORDER FORM PLAN FOR STEP TILES / HOJA DE PEDIDO PARA PELDAÑOS

CUSTOMER: _____ DATE: _____

MODEL AND COLOR / MODELO Y COLOR: _____

DESIGN OF STEP TILE / DISEÑO DE LA PISA/PISADA

STEP TILE / PISA/PISADA

CORNER PROFILE / PERFILE DE CANTO

NUMBER OF EDGES / NÚMERO DE CANTOS

HEIGHT OF FRONT EDGE / ALTURA DE CANTO / FRENTE

OBSERVATIONS / OBSERVACIONES:

COUNTERTOP EXAMPLE
EJEMPLO DE ENCIMERAS



DOWNLAD SHEET ON THE WEB
DESCARGA LA HOJA DE PEDIDO EN LA WEB

Livingceramics COMMANDE DU PLAN DE TRAVAIL / PEDIDO PARA ENCIMERAS

CLIENT / CLIENTE: _____ DATE: _____

MODEL ET COULEUR / MODELO Y COLOR: _____

CONCEPTION DU PLAN DE TRAVAIL / DISEÑO DE LA PISA/PISADA

CONCEPTION DES TROUS DE VIDANGE / DISEÑO DE LOS BUEYOS DE DESAGÜE Y VENTILACIÓN

DIAMÈTRE / DIÁMETRO

NOMBRE DE CÔTES / NÚMERO DE CANTOS

HAUTEUR DU FRONT / ALTURA DE CANTO / FRENTE

OBSERVATIONS / OBSERVACIONES:

CLEANING & MAINTENANCE
 LIMPIEZA & MANTENIMIENTO

Once placed and grout cleaning equipment is mandatory. Improper cleaning may leave traces of products used in the placement or the protection of the tiles, as cements, resins epoxilicas, grout, waxes or fats. For optimal cleaning after placement for cases of intense and stubborn dirt accumulated over time, and for maintenance, required to use the right products. The following table shows some of the recommendations of one of the most prestigious brands.

Una vez colocado y rejuntado el material es obligatoria la limpieza. Una limpieza incorrecta puede dejar restos de productos empleados en la colocación o de la protección de las baldosas, como cementos, resinas epoxilicas, material de rejuntado, ceras o grasas. Para una optima limpieza tras la colocación, para casos de suciedad intensa e incrustada acumulada en el tiempo, y para su mantenimiento, se precisa emplear los productos adecuados. En la tabla siguiente mostramos algunas de las recomendaciones de una de las mas prestigiosas marcas.

FILACLEANER	Maintenance in general. Mantenimiento en general.
FILACR10	Waste epoxy, vitrified, resin board. Residuos de junta epoxi, vitrificada, resinosa.
DETERDEK	Waste concrete placement, limescale, metals stripes, oxide deposits. Residuos de cemento de colocación, residuos calcáreos, rayas metales, depósitos de óxidos.
FILASOLV	Candle Wax, tree resins, tape residue, tar. Cera de velas, resinas arboles, residuos cinta adhesiva, alquitrán.
FILANOPAINT STAR	Painted graffiti, spray acrylic, alkyd and synthetic nitros. Pintadas de grafitis, spray acrílicos, alquídicos y nitros sintéticos.
FILAPS87	Drinks, food, fats, oils, rubber, dyes, marker, acrylic paint drops. Bebidas, comidas, grasas, aceites, goma, tintes, rotulador, gotas de pintura plástica.

INSTALLATION
 INSTALACIÓN

- 1 Conformity of tone and caliber of the material. / Verificar el destonificado del material.
- 2 Make sure that the area to clad is clean and dry. / Asegurar que la zona a revestir está limpia y seca.
- 3 Cement-based adhesive should be used for each type of product; porcelain color body or white body. / Utilizar el adhesivo de clase cemento cola según tipología de producto; porcelánico masa coloreada o pasta blanca.
- 4 The area to clad must be uniformly leveled. The use of leveling systems is mandatory for a perfect installation. / El uso de sistemas de nivelación es obligatorio para una perfecta colocación. La zona a revestir debe estar perfectamente nivelada.
- 5 A 2 mm minimum joint is recommended to place the pieces correctly. / Se recomienda una junta mínima de 2 mm para la colocación entre piezas.
- 6 The rectangular formats cannot be placed united to any more than 3/4 of the piece. / Los formatos rectangulares no se pueden colocar trabados a más de 3/4 de la pieza.
- 7 For the large format (90x90, 30x180) the double bonding technique must always be used. / Para el gran formato (90x90, 30x180) se ha de emplear siempre la técnica del doble encolado.

A LEVELING SYSTEM BY RAIMONDI
 SISTEMA DE NIVELACIÓN RAIMONDI

B LEVELING SYSTEM BY RUBI
 SISTEMA DE NIVELACIÓN RUBI

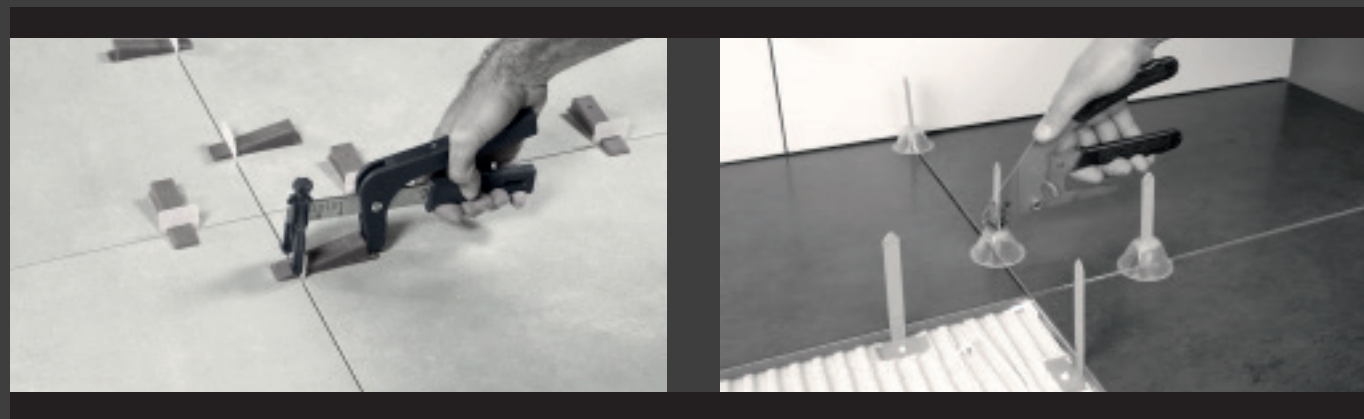

AVAILABLE FORMATS
 FORMATOS DISPONIBLES

Nominal Nominal	Real Real	Price Code Código de Precio	Pieces / Box Piezas / Caja	M ² / Box M ² / Caja	Kg / Box Kg / Caja	Boxes / Pallet Cajas / Palet	M ² / Pallet M ² / Palet	Kg / Pallet Kg / Palet
5x60	4,8x59,8	5	20	0,57	16	24	13,68	384
10x60	9,8x59,8	10	10	0,59	15	24	14,16	380
30x60	29,8x59,8	30	6	1,07	25,6	40	42,8	1044
60x60	59,8x59,8	60	3	1,05	26,8	32	33,6	877
15x90	14,8x89,8	15	7	0,93	24	48	44,64	1170
45x90	44,8x89,8	45	3	1,2	30,9	28	33,6	885
90x90	89,8x89,8	90	2	1,61	41	20	32,2	840
20x120	19,8x119,8	20	5	1,19	31	36	42,84	1137
40x120	39,8x119,8	40	2	0,95	20,3	24	22,87	507
60x120	59,8x119,8	62	2	1,43	37,78	24	34,32	927
20x180	19,8x179,8	21	3	1,07	26,7	36	38,52	981
30x180	29,8x179,8	31	2	1,07	26,8	36	38,52	984
60x180	59,8x179,8	61	1	1,07	26,8	36	38,52	984
7,5x15	7,5x15	7	44	0,5	8	120	60	991
7,5x30	7,5x30	7	22	0,5	8	120	60	991
5x60	5x59,8	Skirting / Rodapié	561	5	3,0 ML	4		
5x90	5x89,8	Skirting / Rodapié	591	5	4,5 ML	5		
5x120	5x119,8	Skirting / Rodapié	521	5	6 ML	6		
33,3x60x3	33,3x59,8x3	Step / Peldaño	360	2	1,2 ML	14		
33,3x90x3	33,3x89,8x3	Step / Peldaño	390	2	1,8 ML	20		
33,3x120x3	33,3x119,8x3	Step / Peldaño	312	2	2,4 ML	24		
33,3x60x3	33,3x59,8x3	Corner / Angular	361	1	0,6 ML	7,3		
33,3x90x3	33,3x89,8x3	Corner / Angular	391	1	0,9 ML	10,5		
33,3x120x3	33,3x119,8x3	Corner / Angular	313	1	1,2 ML	12,7		
5x5	Mosaic 55	Net / Malla 30x30	55	5	0,44	11		
3x15	Mosaic 315	Net / Malla 30x30	315	5	0,44	11		
3x30	Mosaic 330	Net / Malla 30x30	330	5	0,44	11		
5x90	Mosaic 590	Net / Malla 30x90	590	3	0,8	12		
Mureto	Mureto Mosaic	Net / Malla 30x45	300	5	0,45	11		
Hexa	Hexa Mosaic	Net / Malla 30x30	301	5	0,37	9,25		
Moved	Moved Mosaic	Net / Malla 30x30	302	5	0,44	11		
Spike	Spike Mosaic	Net / Malla 30x45	303	5	0,47	11,75		

Updated / Actualizado SEPT. 2014

CONTEMPORARY MIXTURES SURFACES II

Produced by / Producido por
Livingceramics

Printed / Impreso en
SPAIN

Edition / Edición
Cersaie 2014

Livingceramics

Headquarter and Warehouse Oficinas y Almacén

Ctra. Vila-real - Onda CV-20 km.3
Aptdo. Correos 329 Vila-real (CS) 12540
Teléfono +34 964914181
Fax +34 964914250

www.livingceramics.com
info@livingceramics.com

LEGAL INFORMATION
INFORMACIÓN LEGAL

LIVINGCERAMICS Reserves the right to make changes and modifications deemed necessary. Because of the printing process, the colors shown in this catalog are approximate, not exact. The information in this catalog is fully protected by copyright. Total or partial reproduction of text, illustrations, images and graphical representations is forbidden without the express permission of Living Ceramics.

LIVINGCERAMICS Se reserva el derecho de hacer variaciones y modificaciones que considere oportunas. A causa de los procesos de impresión, los colores que aparecen en este catálogo deben considerarse aproximados, no exactos. La información de este catálogo está protegida en su totalidad por copyright. Está prohibida la reproducción total o parcial de los textos, ilustraciones, imágenes y representaciones gráficas sin la autorización expresa de Living Ceramics.

Livingceramics